

## Introduction

This resource pack is intended to assist coaches and their paddlers in getting the best use out of their padding ergo.

The padding ergo is now seen more and more in clubs, centres and local gyms, they even occasionally appear in the bedroom of the more dedicated paddler. Hopefully this pack will be an ever evolving one, with additions when more ideas and feedback come forward. It is also hoped that it will develop into a more complete pack for working on the water as well as off of it and be a worthwhile reference for the coach.

The pack is aimed at 'Paddlesport Start' in the Long Term Paddler Development Plan and will fit into the LTPD 'Learn How to Train' phase of a paddler's development. The target age range of young people in Paddlesport Start is 8 to 10 years for boys and 7 to 9 years for girls, these exercises and drills will, however, benefit anyone in their early years of paddling participation and development regardless of their age.

It is certainly not intended as a replacement for the coach, but more of a means of assisting those with less of a racing and coaching background than others and who are not in a situation to gain the knowledge and experience from years of racing paddling, training and coaching.

Some of the content will remain in the folder, whilst some is intended to be used as a work card in the gym or training room to assist in guiding the coach and the paddler through the session.



### The paddling ergo

The paddling ergo has been developed over a number of years as a means of re-creating the kayak or canoe paddling action on dry land and make it as close as possible to the stroke as performed in the boat. The design of the ergo enables the paddler to adopt the same seating position they would in the boat, and the flywheel, with air-braked resistance means that the pull and the glide in the boat can be quite faithfully reproduced.

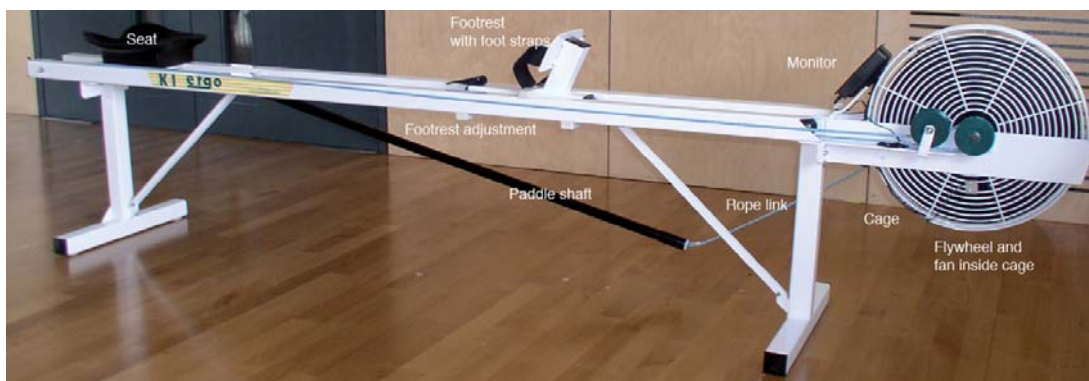

The ergo has the benefit that it can be used indoors, away from inclement weather and that the paddler has a stable platform from which to work when learning and developing their technique. The Coach can also use a 'hands on' approach for correction and modifying the stroke. Because the paddling ergo has quite a small 'footprint', several machines can be used in the same training area without compromising space too much. Use of computer technology can further enhance the benefits and give instant feedback relating to the training session

There are a number of uses and benefits of the ergo from the beginner through to elite performer

- \* Introduction and promotion of paddlesport
- \* Technique training and development
- \* Fitness training and development relative to the sport
- \* Warm-up device prior to water session

- \* Rehabilitation device following injury
- \* Aid for sports science Research and Testing

The ergo is an ideal tool to introduce young people to paddlesport in schools and community settings. It can be used to set time or distance challenges and/or linked to the curriculum for specific learning outcomes. Though it can be a problem to transport if you and / or your car are small and you are on your own.

### **Technique development and development**

For the beginner there are a number of drills and practices that can be used to ensure good technique can be learnt and felt for future transfer to the boat. It has an advantage in that corrections can be made easily by the coach, who can be in close proximity all through the session. It can be included in the paddlesport start stage of a young paddler's development.

### **Fitness training and development**

As the paddler starts to develop then the Ergo can be used as a training tool on land, and is ideal for use when faced with time restraints or bad weather/conditions. Similar sessions to those on the water can be used and with feedback from computerised displays much information can be gained from the session on the ergo

### **Warm-ups**

Because it faithfully reproduces the paddling action, the ergo can be used before a training session or competition as part of the warming-up routine.

### **Rehabilitation**

With the ergo being land based, it is an ideal way for the paddler to return to paddling in controlled conditions after illness or injury.

### Testing and research

In a controlled environment, the ergo can be used in the sports science laboratory as a means of testing various components of a paddler's performance

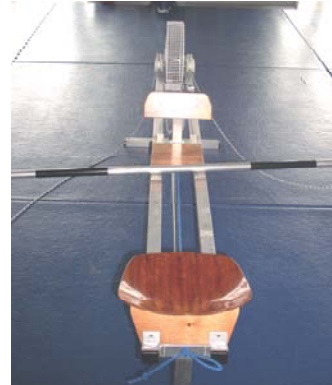

### Setting up

#### 1 Location and Space:

The Ergo should be on a flat, stable surface with a 'no go' area of 2.0 metre each side from the centre line of the Ergo. (See Safety and the Ergo section)

#### 2 Checking Fittings.

All fittings should be checked that they are secure, tightened and in the correct place for the paddler

#### 3 Pulley/shock cord adjustments

The shock cord that adjusts the bungee tension for the return should be just tight enough to take out any 'flapping' of the rope on the recovery side of the stroke

#### 4 Paddle Length/Grip:

The machine can be set up with a smaller shaft (which is more suitable for small hands), or a shaft which is adjustable in length to help with load adjustment. Both are available from Lawler Engineering.

#### 5 Rope Length.

With the Lawler Ergo, a rope length of 5.7 metres for its complete length will enable both the bigger paddler as well as the smaller one to use the same machine.

## 6 Youth sized ergo.

For U11's a smaller ergo is available from Lawler Engineering.

## 7 Changing load.

The load on the machines needs to be variable to cater for a wide range of users; this can be done either by blocking off the airflow through the fan or by changing the length of the paddle shaft. For time trials the alteration to the paddle shaft length is the preferred method.

## 8 Footrest adjustment:

The ideal leg angle is about 120° at the knee with the feet firmly on the footrest resting at an angle of 45°

## 9 Calibration.

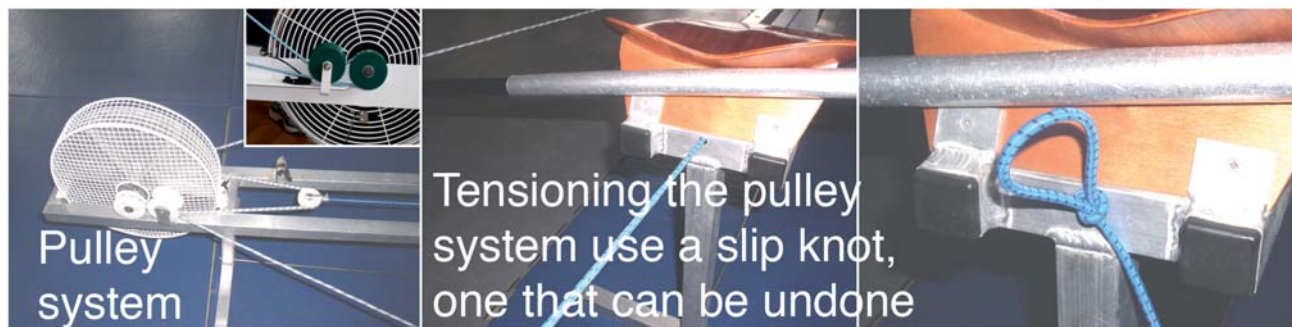

Individual ergos can be calibrated to give the same results further details contact [www.mike-sport.net](http://www.mike-sport.net).

It is quite possible that the ergo machine may have to be assembled before use.

In this case you should refer to the manufacturers instructions.

### **Equipment needs for introducing & developing kayak paddling technique**

#### **Dry land development**

In an ideal group situation the following would be required:

1. Plenty of space, both indoor and outdoor, so choice can be made depending on the weather.
2. Sufficient equipment, so there is plenty of activity for the maximum number of people possible.
3. Paddle shafts, smooth wooden doweling or broomsticks of similar diameter to a paddle shaft, enough to at least provide 1 between 2 people.,
4. Something comfortable to sit on, so the backside can be raised off the ground and higher than the heels: gym mats, foam cushion. Or even a seat pan that is stable on the ground.
5. Something to push the feet against, this could be a wall, solid object on the ground, or the feet of the paddlers partner in the exercise.
6. A paddling ergo with fittings suitable for the age/size of the paddler.
7. A dedicated area with a mirror so placed that the paddler can observe their own technique.
8. Clock or stopwatch.
9. A coach
10. Video camera and computer for analysis (Not essential but a very useful tool if available)

#### **Paddle dimensions**

For kayak paddling there are 3 main factors in selecting the correct paddle: length, blade size, and paddle shaft diameter.

### **Length:**

A good starting point for kayak paddle length is for the paddler to be able to curl their fingers over the top blade of a vertical paddle with an outstretched arm. For the ergo paddler the paddle shaft needs to be about 50 cms. shorter than the total length of the paddle they would use in a boat.

### **Blade size:**

There are various blade shapes and sizes available for the kayak paddler. However with the ergo, the blades are not needed, neither is it necessary to have blades on the end of paddle shafts when using paddle shaft drills on land.

### **Paddle shaft diameter:**

This should be of a diameter that the paddler, particularly the younger one, can comfortably wrap their fingers around the paddle shaft, so the thumb and forefinger can overlap. Smaller diameter paddle shafts are available

### **Hand Grip**

Once the correct dimensions of paddle have been decided, then it is important that a good, comfortable hand grip and position is established. The paddler should place the centre of the paddle shaft on the head and then move the hands out along the shaft



Photo illustrates optimum hand grip

until a 90o angle is created at the elbow. This will give a good starting position for the hands as it enables the paddler to utilise their back and shoulders and not rely just on the arms for using the paddle

### **Ergo paddle shaft**

As said before, typically the paddle shaft used on an Ergo would be 50cms shorter than normal kayak paddle length. It is however important to experi-

ence the feel of the shaft by doing some strokes at a cruising speed and at a faster pace to see what is comfortable for the paddler.

### Safety and the ergo

Before using the Ergo at the start of a session there are a number of safety checks to be made: Ensure the ergo is on a flat, stable surface, check that the ropes are in good condition, not frayed or knotted and that they are secured properly to the paddle shaft. Check that the seat and footrest are both secured firmly to the frame and that the foot straps are also in good repair. Make sure that the pulleys are running freely and there are no obstructions that will prevent the fan spinning freely. Before commencing the activity, the paddler should be 'warmed up' and 'stretched', the settings on the machine should be correct for their size, age and ability. If in doubt, get the Coach to check

The ergo needs to be in enough space that there is no possibility of any object getting in the way of the paddle stroke, or that anyone nearby is injured as a result of the paddle shaft being used.

There should be a 'no-go' area around the paddling area that no one is allowed in, whilst the ergo is being used. Should there be a number of ergos being used in one area, then they should be sufficiently spaced so that two paddle shafts do not collide and that anyone trying to pass through, or get on or off another machine is not affected in doing so. The 'no go' area should be 2 metres each side from the centre line of the ergo.

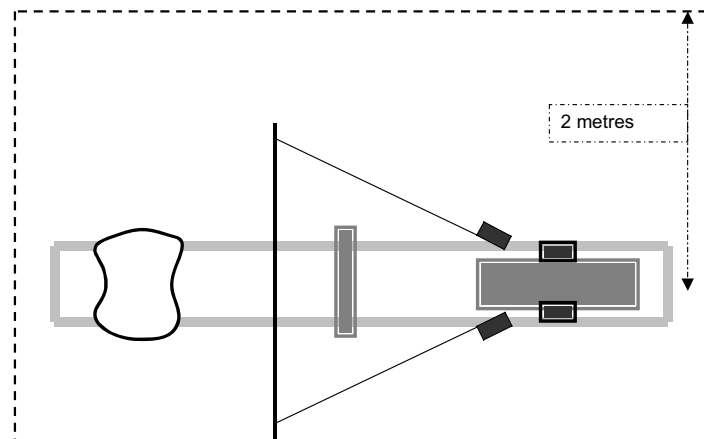

The 'no go' area should be 2 metres each side from the centre line of the Ergo.



### Risk control

In order that injuries and accidents can be minimised the following needs to be taken into consideration prior to paddlers using the ergo.

Hazard	Who might be harmed	Advice for controlling the risk	Further Control Measures
Finger Entrapment	Users and onlookers	Warnings about putting fingers in cage and near pulleys	
Strain injuries	Users	Use appropriate shaft and resistance for the paddler. Instruct not to over exert or use for too long	
Strain injuries	Staff	Lifting and handling advice and training given	
Being struck by shaft	Onlookers	Use 'no go' area to exclude onlookers from immediate vicinity of Ergo	
Exercise induced stress	Users	Do not pressure users when using the Ergo	
Slips and trips	All	Ensure floors are suitable, that the footwear worn is suitable and adequate, that there are no items of equipment lying around. Other training activities are kept at a distance	
Falling off Ergo	Users	Training in technique and balance given, beginners observed at all times	
Ergo Collapsing	Users	Ensure all adjustments, nuts and bolts are secure and functional	

### Linking to computers

An ergo can be linked to a computer to give a lot of information and feedback to the paddler. Both machines are capable of being connected, with additional interfaces, to a computer to give much more accurate and comprehensive feedback.

The Australian K1 Ergo has a more sophisticated 'speedo' than the Lawler ergo, with stroke rate and power output as well as speed and distance being displayed. For the beginner there is little need for the Speedo to be used as the machine will be very much used for technique training and development. In general practice it is preferable to use the ergo 'built-in' Speedos when time trials are being done,

One of the 'packages that has been developed to give greater and better information and feedback is 'PaddleMonitor' PaddleMonitor software has been developed to give coaches and paddlers unrivalled feedback on paddling performance issues in combination with the Lawler paddling ergo. This combination of paddling machine and software has been chosen by the GB Olympic Sprint Team as their 'off water' performance monitoring system leading up to the Beijing Games.

The 'PaddleMonitor' Software can be used in conjunction with the 'K1 ergo', but this has to be upgraded with a flywheel from the 'Lawler' ergo. The screenshot shows the situation at the end of the 766th stroke (top right), 8mins 34sec into a 2000m time trial (195.7 metres left to go). As the paddler started on the right, all even numbered strokes were made on the left. The force curve (blue) for this stroke is shown on the graph along with the variation in boat speed (red) throughout the stroke. The items on the right show values for this specific stroke, plus the average

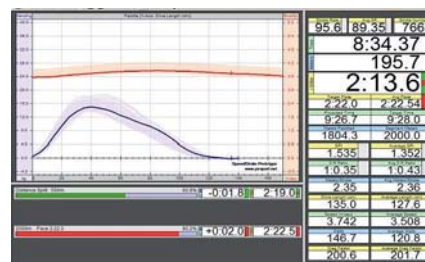

Paddle monitor software

values for the run so far. These include items such as stroke rate, stroke length, power output, drive ratio (ratio of stroke to recovery time)

The target for this trial was a 500 metre pace of 2m 22s, and 500 metre splits were selected. The bottom red bar indicates the pace for the whole piece is slower than required. The 500 metre 'splits' bar above that shows the pace during the final 500 metres is above that required. At the end of the run each stroke can reviewed if necessary (that's all of about 840 for this run!).

Information can be exported in the form of text files for the importation into a spreadsheet for further analysis.

The software runs on a PC using the Microsoft XP (Home or Pro) operating system. The upgrade of a Lawler machine to with PaddleMonitor involves calibrating the flywheel, addition of extra sensor magnets, and the fitting of a new pick-up sensor.

### **Warm ups**

Warm-ups are fun activities and should be done before a work-out or training session. The warm-up has several functions.

- Avoidance of injury,
- Improving performance,
- Increasing flexibility,
- preparing the body for the activity to come.

The warm up should initially gently raise the heart rate, this can be through gentle jogging, some interactive ball games, skipping. Ice breaking games. Carried out for about 5 minutes, followed by gentle stretching exercises these should be all over stretches, taking care to stretch muscles over the whole body not just the arms! Followed by some kayak specific activity, ether in a boat or on a Paddling Ergo. It is important to remember that the more intense the training or event activity is likely to be, the longer time should be taken over the warm up.

After the training session or race then a 'cool-down' should take place. This serves to prevent stiffness after the session and promote better and faster recovery ready for the next session or race. This can be carried out by Light paddling on the water, or on an ergo, to slowly bring the heart rate back to normal. Gentle stretching off the water, repeating the stretches in the warm-up' before the session, showering after the session will also promote recovery, as well as being essential for good hygiene practice

### **Warm up games**

There are many warming up games that can be played both as ice-breakers for a new group, or to prepare the body for the stretching exercises to follow.

- Relay races (running and jumping to numbers)
- Paddle circles: (passing paddles around circle,) (running round circle, paddles remain)
- Throwing and catching a rescue throw bag in a circle
- Running and jumping, touching floor to commands
- 'Supermarket trolley' Game
- 'Getting out of bed' Game

There are a number of warm up games described in the latest 'Canoe Games' book by Dave Ruse and Loel Collins.

## Technique Development Work Card 1

### Land drills to develop rotation and awareness

These drills are best performed with a paddle shaft, without blades, or a broomstick of the right diameter

#### 1 Standing exercise i

Standing Exercises, with paddle shaft behind neck resting on shoulders, hands in correct position, rotate body, to the left and to the right, keeping the back straight and upright. The head is kept still and fixed on a point in front, as the rhythm develops, then the legs are used to assist the rotation

Do not rotate too far and do not 'bounce back' from the previous rotation

Repeat 15 times in each direction

#### 2 Standing exercise ii

With paddle shaft in front with arms outstretched in front and paddle shaft at shoulder height. Same rotation as (1), keep the shaft horizontal, head facing forward and do not take the hands past 90° of the direction the head is facing, the shoulders and paddle shaft always remain parallel

Repeat 15 times in each direction

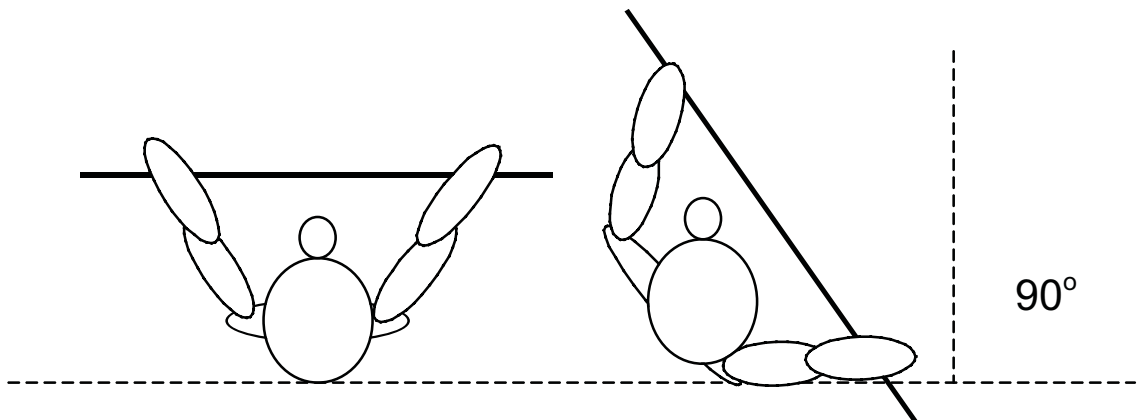

### 3 Standing exercise iii

With arms starting in same position as the previous drill, the right hand paddle is dropped until the paddle shaft is about 45 degrees across the body; the rotation is performed in exactly the same way, keeping the right side of the paddle shaft down all the time, rotating from the front to the side, then round to the same side again. The angle of the paddle shaft, when viewed from the front remains the same throughout the stroke and that the shoulders and the paddle shaft remain parallel. The action is then repeated.



### 4 Leg action

The power, particularly at the front of the stroke, comes from the legs, there should be pressure on the footrest to facilitate body rotation. The leg drive pushes the hip back. This can be seen as the leg is lowered and the paddler's bottom slides back on one side of the seat. Students can be reminded to drive their legs, one at a time, against the footrest. Observe that the lowered knee should be up to 100cm lower than the other knee.

### 5 Full Stroke

The two sides are 'joined together' concentrating all the time on the rotation and the body, rather than the arms, moving the paddle shaft: Think of the arms as a method of joining the paddle shaft to the body and not for moving the shaft.



## Technique Development Work Card 2

### Developing the technique work on the Ergo

**Leg Drive** – The leg drive is the first part to be emphasised when seated, the paddler should push on the footrest to extend the leg, flattening the knee, thus pushing the hip back, this is the initiation of the drive and the rotation. As the practice develops, then commencement of each stroke can start very hard and fast, care being taken not to over rotate, the leg action can now be reinforced,. The leg should start to push against the footrest just before the 'Catch Position'; this will ensure that there is power generated from the moment the paddler is ready to pull the shaft back.

1. Repeat previous exercises with resistance from flywheel

- Introduce the leg drive
- Rotation with shaft behind head
- Rotation with arms outstretched in front of body
- Rotation with paddle shaft at angle across body, one side at a time, then linking the two sides

2. Connect Shaft to ergo and introduce resistance gradually keeping it low to ensure technique does not 'break down'



3. Repeat previous exercises with resistance from flywheel

These can also be used as warming up exercises, or as reinforcement of the earlier practices, the leg drive should be used to assist with the rotation.

Coaching points: Shoulders and shaft remain parallel; the angle of the shaft across the body remains the same when viewed from the front and there is very little overtaking of the top hand over the bottom hand, when viewed from the side



The complete paddling cycle on the ergo compared with the boat

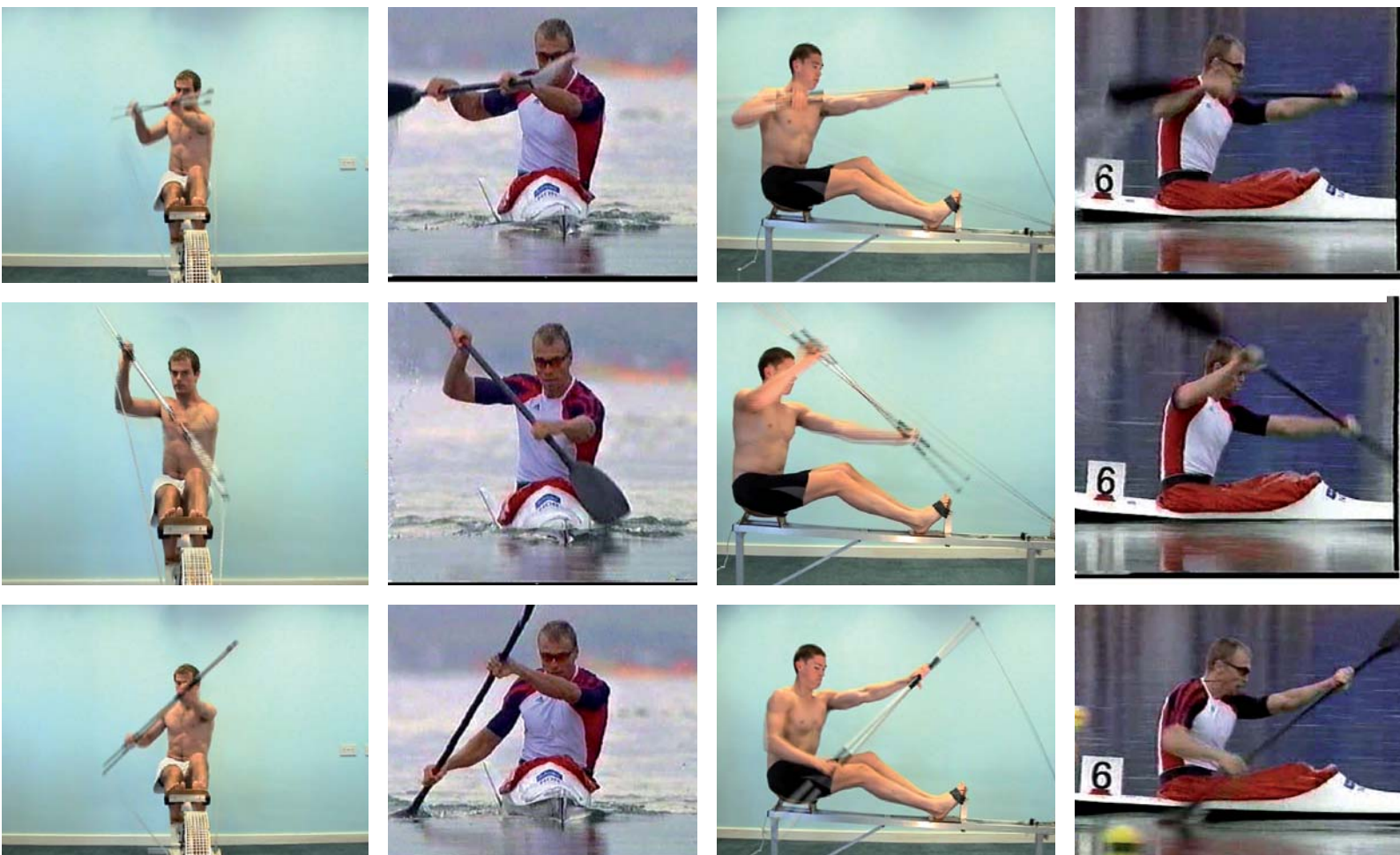

Possible layouts during training sessions

Depending on the layout and space available within the training area, then different arrangements of the Ergos can be used to enable the Coach to monitor a number of paddlers with the minimum use of space.

Star layout

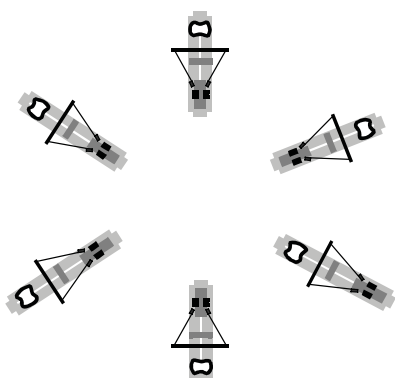

Parallel layout

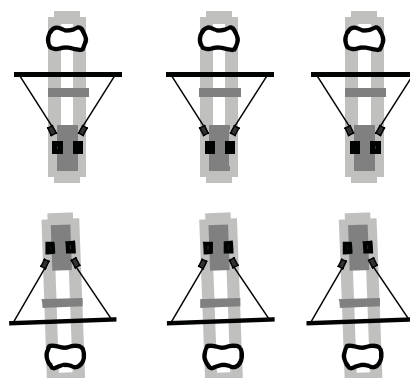



Ergos in the circuit session

Where circuit training sessions are run, the Ergo can fit quite easily into the circuit plan and is sometimes best used here when there are many paddlers and only a couple of Ergos.

A circuit such as below would occupy 20 paddlers with 2 ergos and minimal other equipment apart from mats and benches

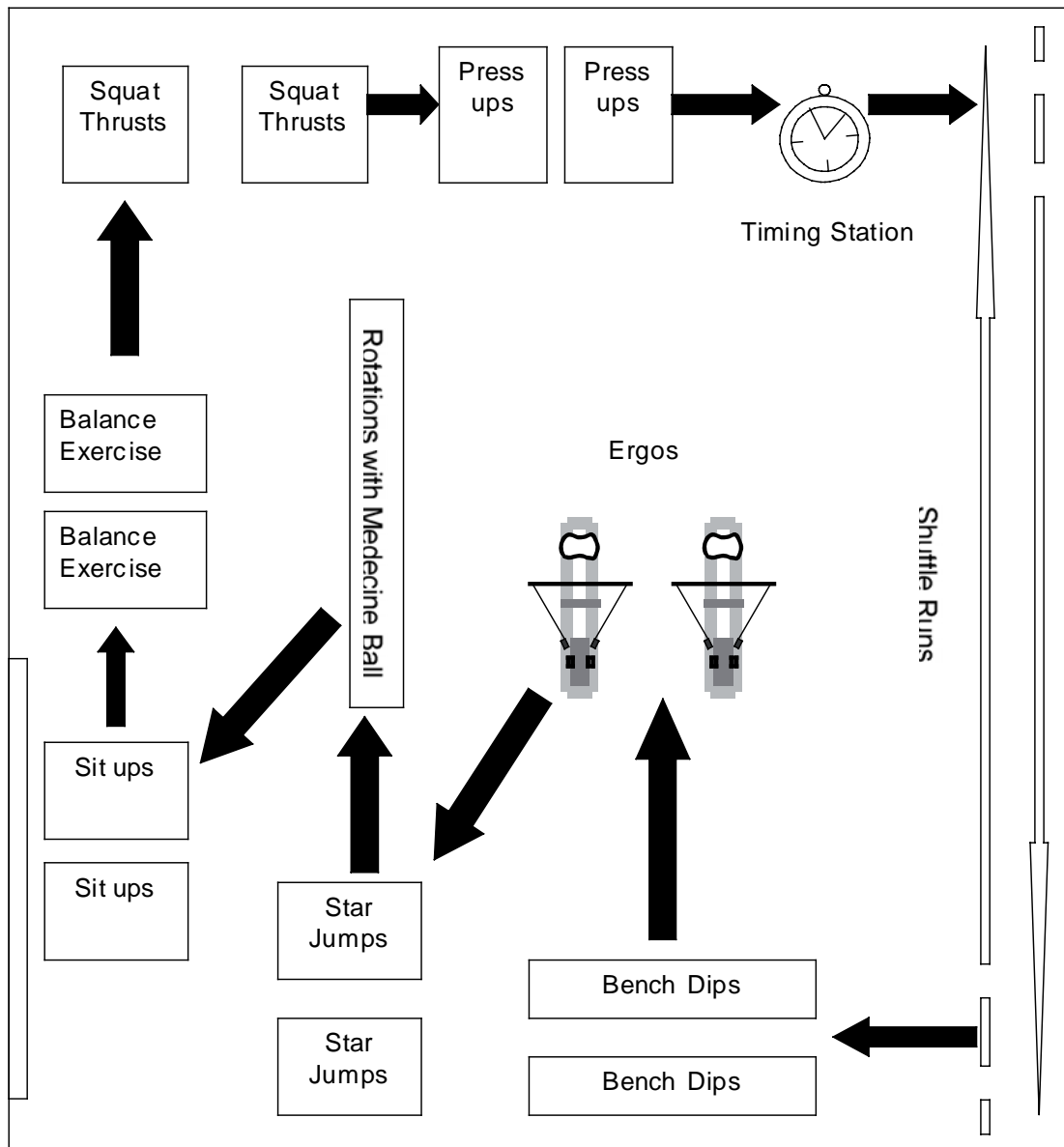

### **A one hour training session for young paddlers**

Warm up activity, 10 minutes

- Gentle jogging to raise heart rate
- Warm-up game(s) to encourage stretching and bending

Technique work with paddle shafts or broomsticks, 10 minutes

- Working in pairs concentrating on leg drive and rotation

Circuit similar to plan 30 minutes

- 10 stations with 2 on each station
- Working in pairs, 30 seconds on 30 off alternately
- 1 circuit taking 10 minutes
- 3 laps of the circuit

Cool down activity 10 minutes

Gentle stretching exercises to decrease heart rate slowly

### **Other ways of using the ergo for development, training and fun**

Set challenges:

**Relay races** with each person in a large group taking their turn, this could be against another team on another machine, or just to set a challenge to achieve over a certain period of time.

**A 'Boat Race'**

**A 10 K race** or challenge

**Channel Crossing**, this could be to cross the English Channel (21 miles)

**A full marathon 42kms**

**Devises to Westminster Canoe Race**, 125 miles, this could be made more interesting by having 77 running sectors during the ergo work to simulate the portages along the real course.

Each person need only do 30 seconds effort each time, depending on their development, as they progress, then the time on the Ergo can be extended.

## **The Ergo Boat Race**

A challenge to see how a team of Paddlers on the Ergo would compare with the boat race crew in the annual Oxford and Cambridge boat race

### **Requirements:**

Teams of 8 paddlers

Enough ergos, with counters, for the number of teams

Stop Watch

Plenty of room around the ergos

Session

Briefing 5 minutes

Warm up 10 minutes

Practice Changeovers 5 minutes

Boat race 30 minutes

Cool down 10 minutes

Each person can be on the Ergo for an equal amount of time, maybe for 30 seconds, up to a minute

The distance of the rowing boat race is 4 miles 374 yards, or 6778 metres.

The time taken for the rowers is usually between 16 and 17 minutes and the crews do about 600 strokes for the distance. Any of this data could be used to set the challenge. For example if the ergo is calibrated then the distance travelled could be used, if not the number of strokes could be used as the measure with 1200 strokes being the number used

### Balance and stability

In addition to developing technique on the Ergo, it is of vital importance that the paddler spends time working on their Core and Functional Stability, this will enable them, when progressing into the boat to be able to generate maximum power in driving the boat forward without using energy keeping themselves and the boat balanced.

There are a number of exercises that can assist in this development. Using little or relatively inexpensive equipment.

Use 2 Swiss balls of different sizes, sit on the larger one and put the feet on the smaller one, learn to balance whilst on them. Balance with both feet, then one and then the other. Try paddling whilst sitting on them. There are many other exercises that can help develop stability using the Swiss Ball.

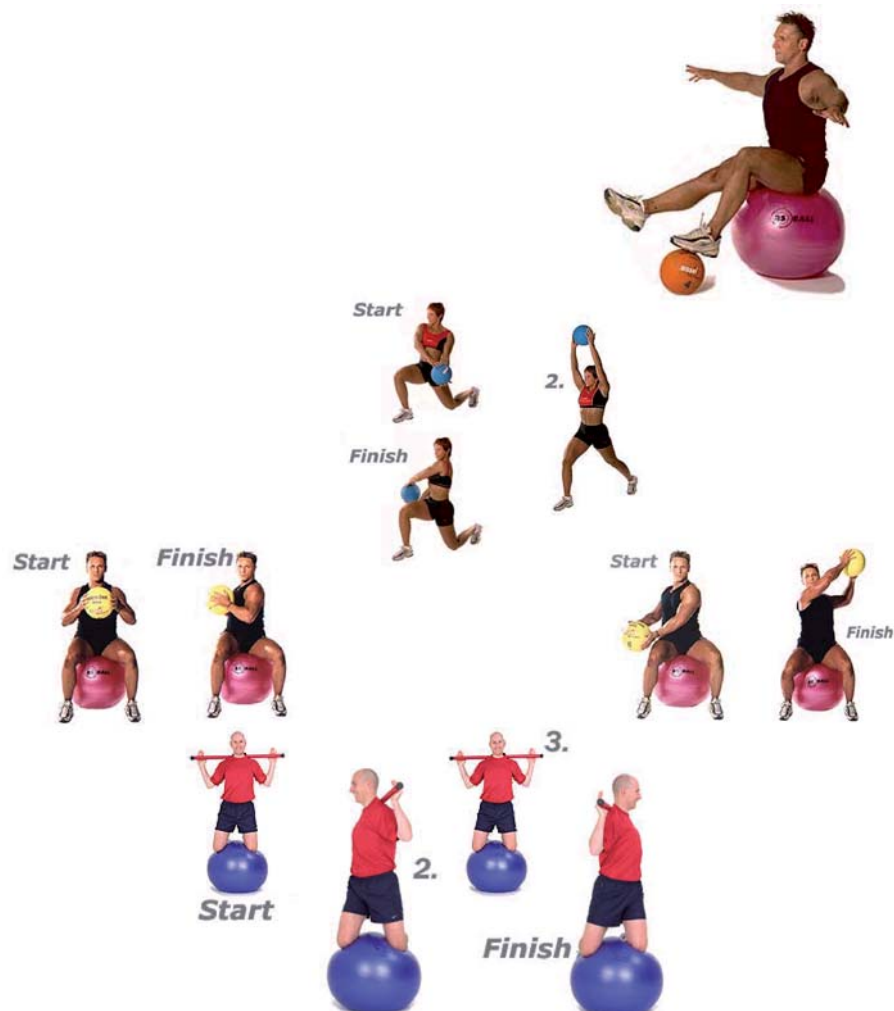

Resource Material

BCU Long Term Paddler Development Pathway

Comparing Results on Air Braked Paddling Ergos, Mike Phillip

Canoe Games – Dave Ruse and Loel Collins

Functional Stability for the Paddling Athlete, BCU, Joanna Elphinstone

**Contacts:**

**Mike Phillip**, info@mike-sport.net +44 (0) 208 224 1923 PHILLPETTE LTD, 21

Avondale Avenue, Surrey, KT10 0DB, Hinchley Wood, UK

<http://www.mike-sport.net/>

**Roger Cargill**, k1ergo@netspeed.com.au 61 2 62815 660

59 Gilmore Crescent, Garran ACT 2605, Australia

**Lawler Engineering**, 42a School Road, East Molesey, Surrey, KT8 0DN, UK,

Tel & Fax: +44 (0) 208 979 4993

**National Development Coaches**, BCU John Dudderidge House, Adbolton Lane,

West Bridgford, Nottinghamshire, NG2 5AS, 0115 9821100

Oz ergo detail